

SEZIONE BASE LEVELLO E PENSILI SCOLAPIATTI

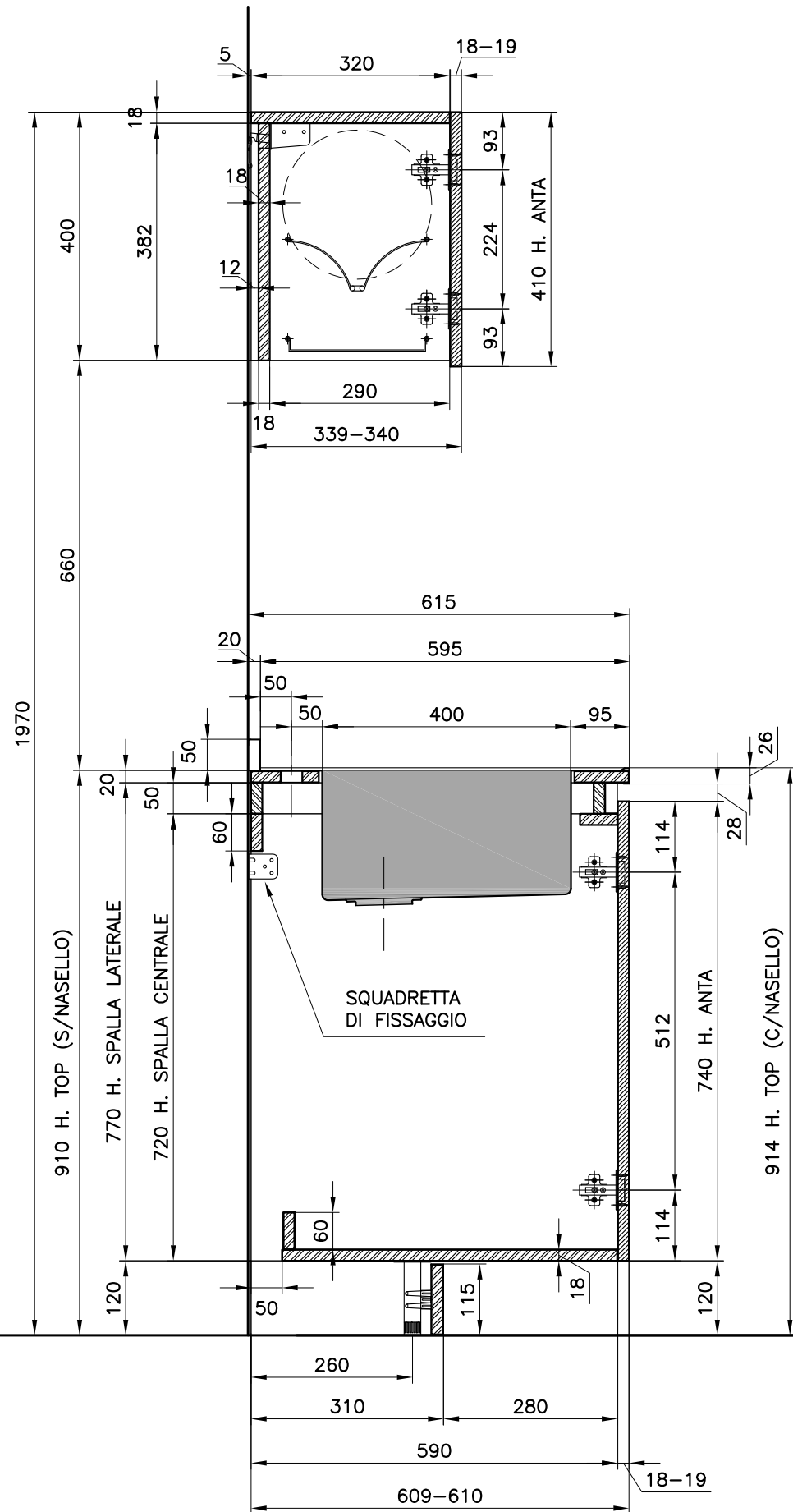

SEZIONE BASE FRIGO-COTTURA E PENSILE CAPPA

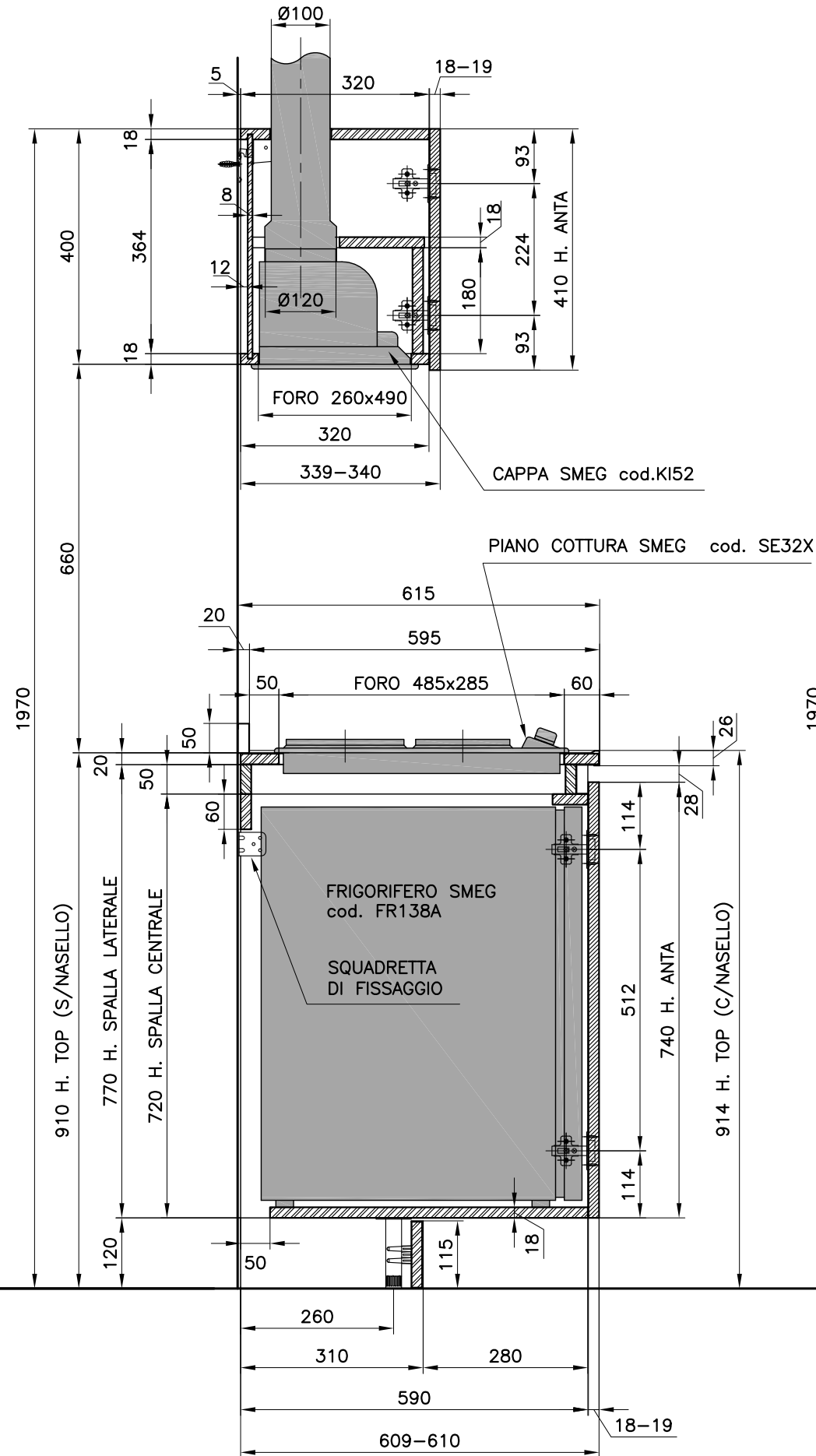

SEZIONE BASE CASSETTIERA E PENSILE

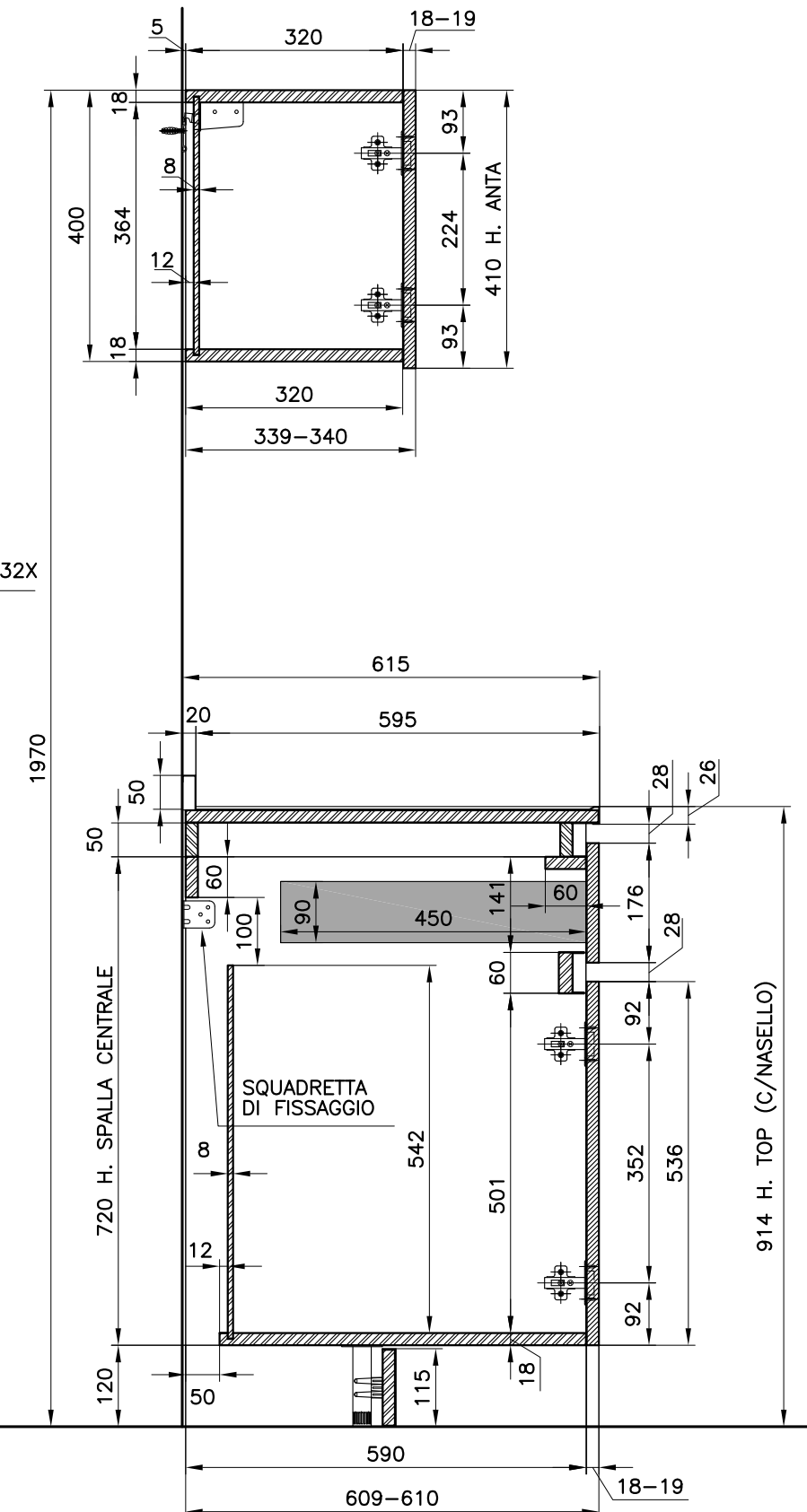

Studio GALMAR PROGETTAZIONE e DESIGN - SETTORE ARREDO 20833 GIUSSANO (MB) Italy - P.zza Repubblica, 1 Tel. +39 0362 351107 - E-mail: info@studiogalmar.it <small>PROPRIETA' E DIRITTI RISERVATI, TUTELATI A NORMA DI LEGGE</small>		descrizione:	
		SEZIONI CUCINE	
progetto:	data:	scala:	formato:
RIVANAZZANO	29-05-2012	1:10	A3
riferimento:	aggiornamenti:	codice documento:	
	11-06-2012	RIV D.001a	

SEZIONE BASE FRIGO-COTTURA E PENSILE CAPPA

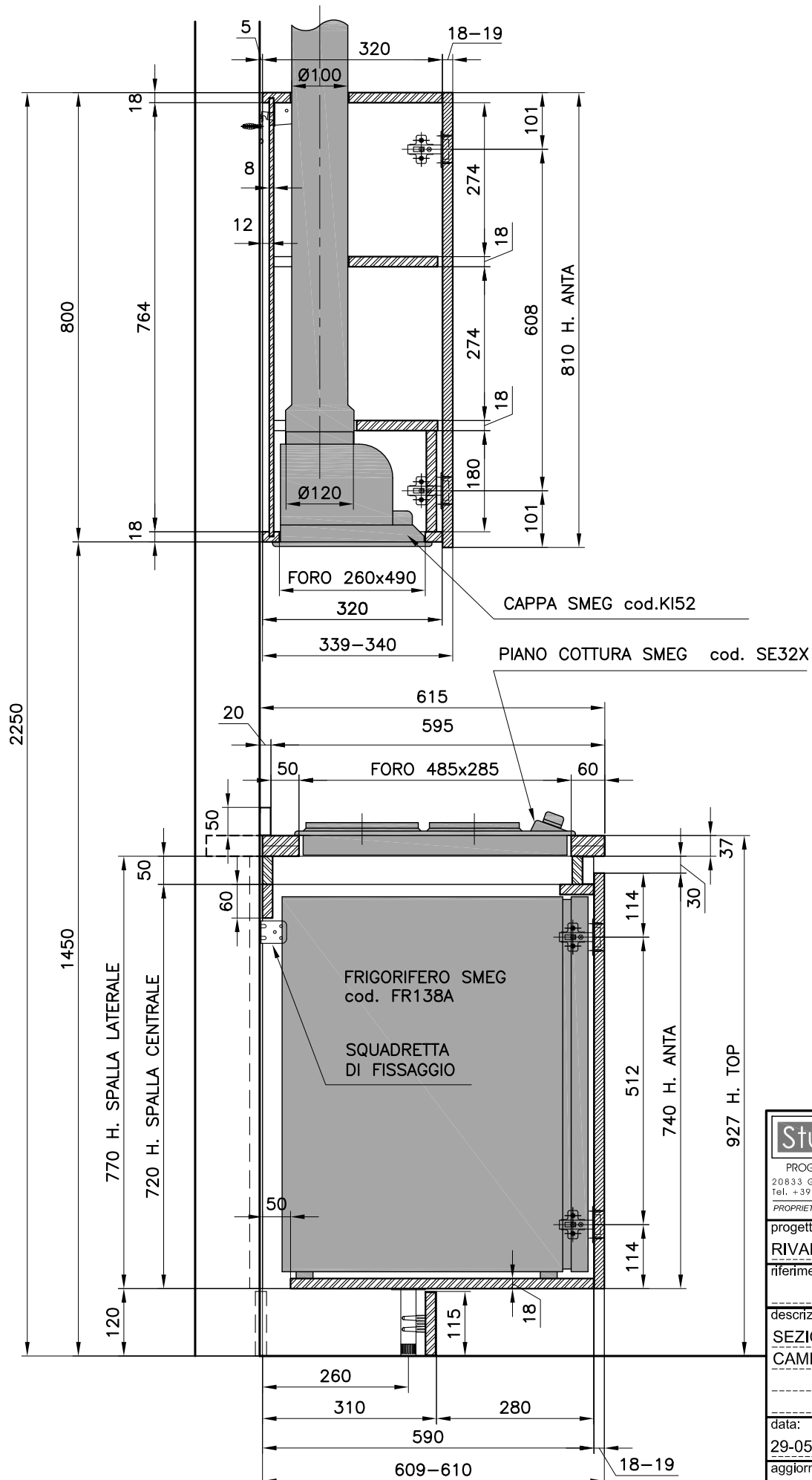

Studio GALMAR		
PROGETTAZIONE e DESIGN - SETTORE ARREDO 20833 GIUSSANO (MB) Italy - P.za Repubblica, 1 Tel. +39 0362 351107 - E-mail: info@studogalmar.it PROPRIETA' E DIRITTI RISERVATI, TUTELATI A NORMA DI LEGGE		
progetto:		
RIVANAZZANO		
riferimento:		
descrizione:		
SEZIONE CUCINA		
CAMERA 3		
data:	scala:	formato:
29-05-2012	1:10	A4
aggiornamenti:	codice documento:	
	RIV D 002	

VISTE IN PIANTA

CAMERA ①

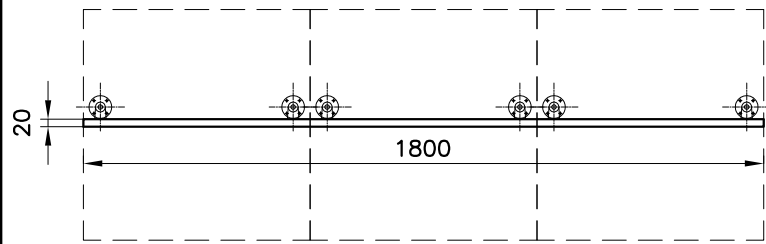

CAMERA ②

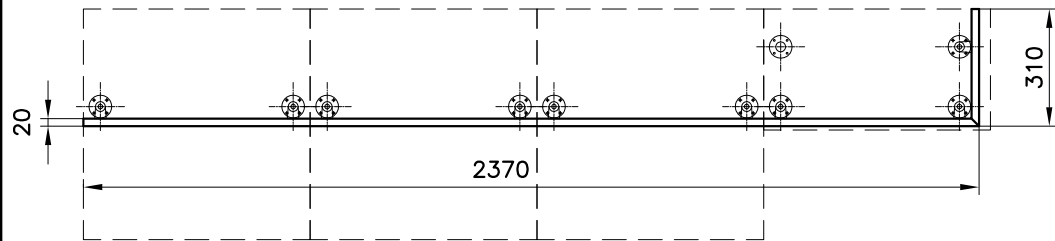

CAMERA ③

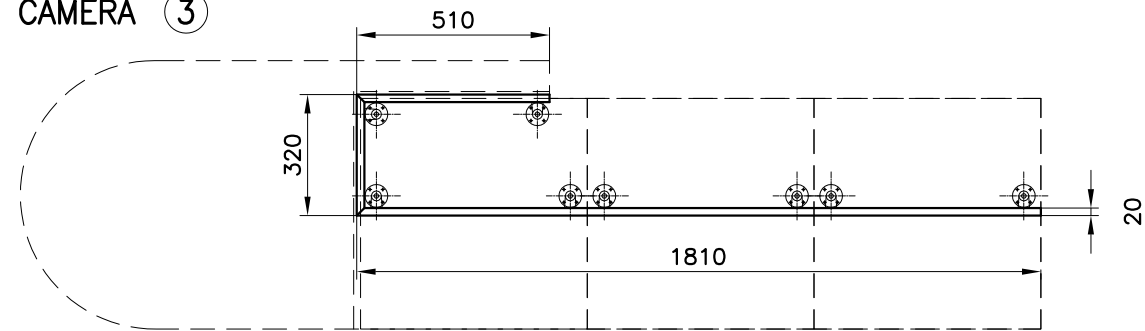

CAMERA ④

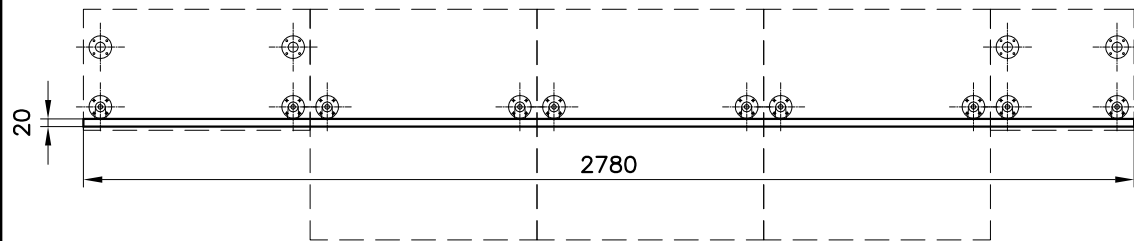

CAMERA ⑤

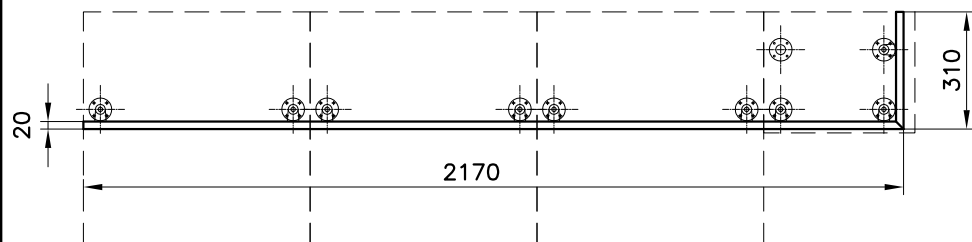

CAMERA ⑥

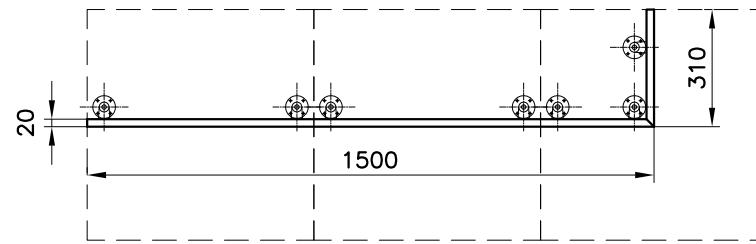

CAMERA ⑦

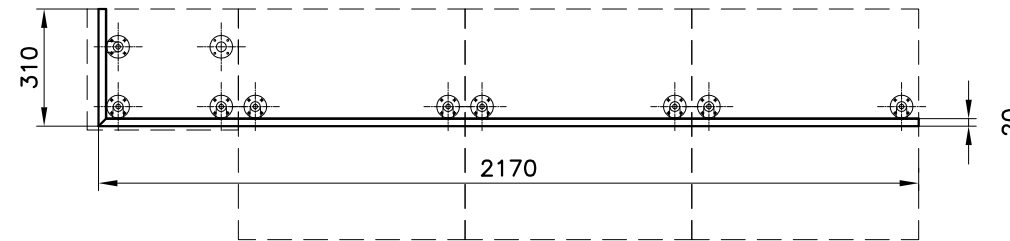

CAMERA ⑧

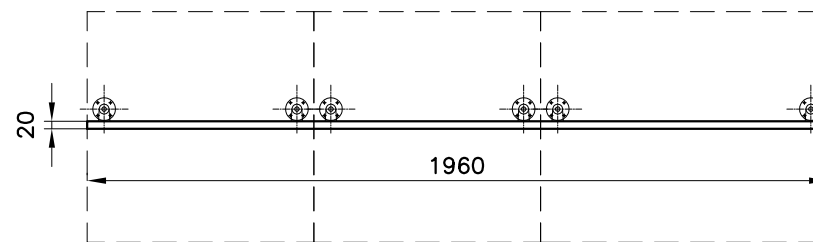

CAMERA ⑨

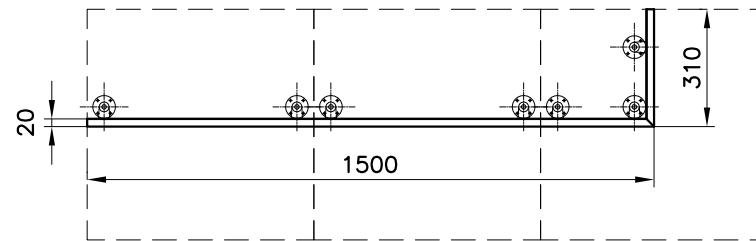

SEZIONE scala 1:1

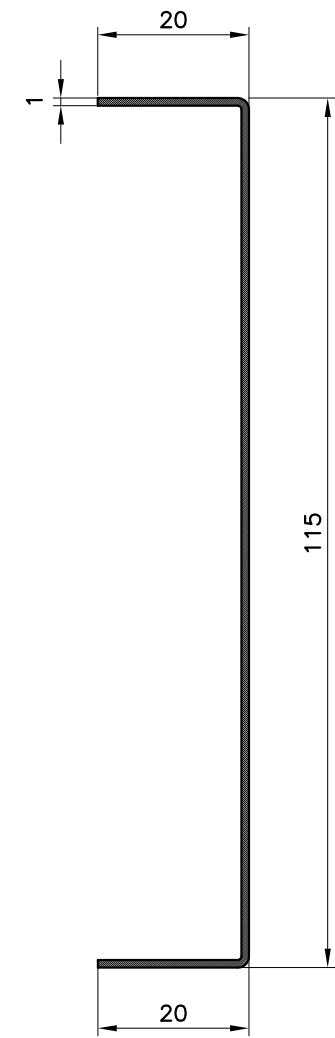

SEZIONE IN ASSIEME scala 1:2

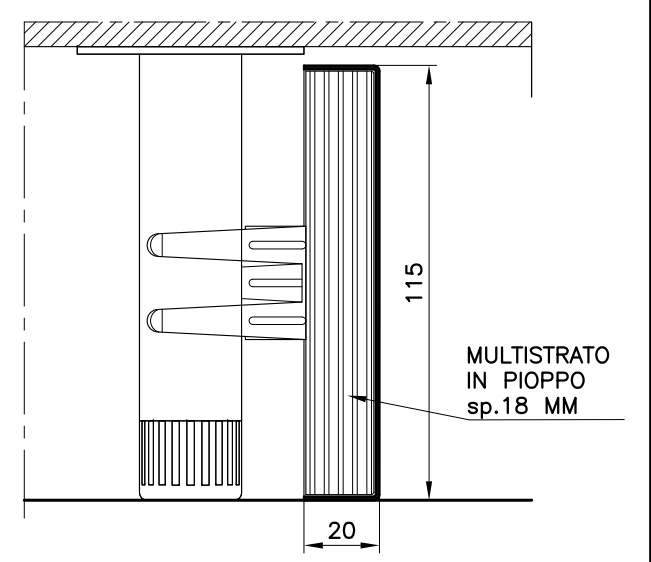

RACCORDARE GLI SPIGOLI SALDATI
LAMIERA ACCIAIO INOX 10/10

Studio GALMAR PROGETTAZIONE e DESIGN - SETTORE ARREDO 20833 GIUSSANO (MB) Italy - P.za Repubblica, 1 Tel. +39 0362 351107 - E-mail: info@studiogalmar.it <small>PROPRIETA' E DIRITTI RISERVATI, TUTELATI A NORMA DI LEGGE</small>		descrizione: ZOCCOLI ACCIAIO INOX	
progetto: RIVANAZZANO	data: 29-05-2012	scala: 1:20	formato: A3
riferimento:	agglomeramenti:	codice documento: RIV D 011	

PIANTA DEL TOP - LAVELLO SX / PIANO COTTURA DX

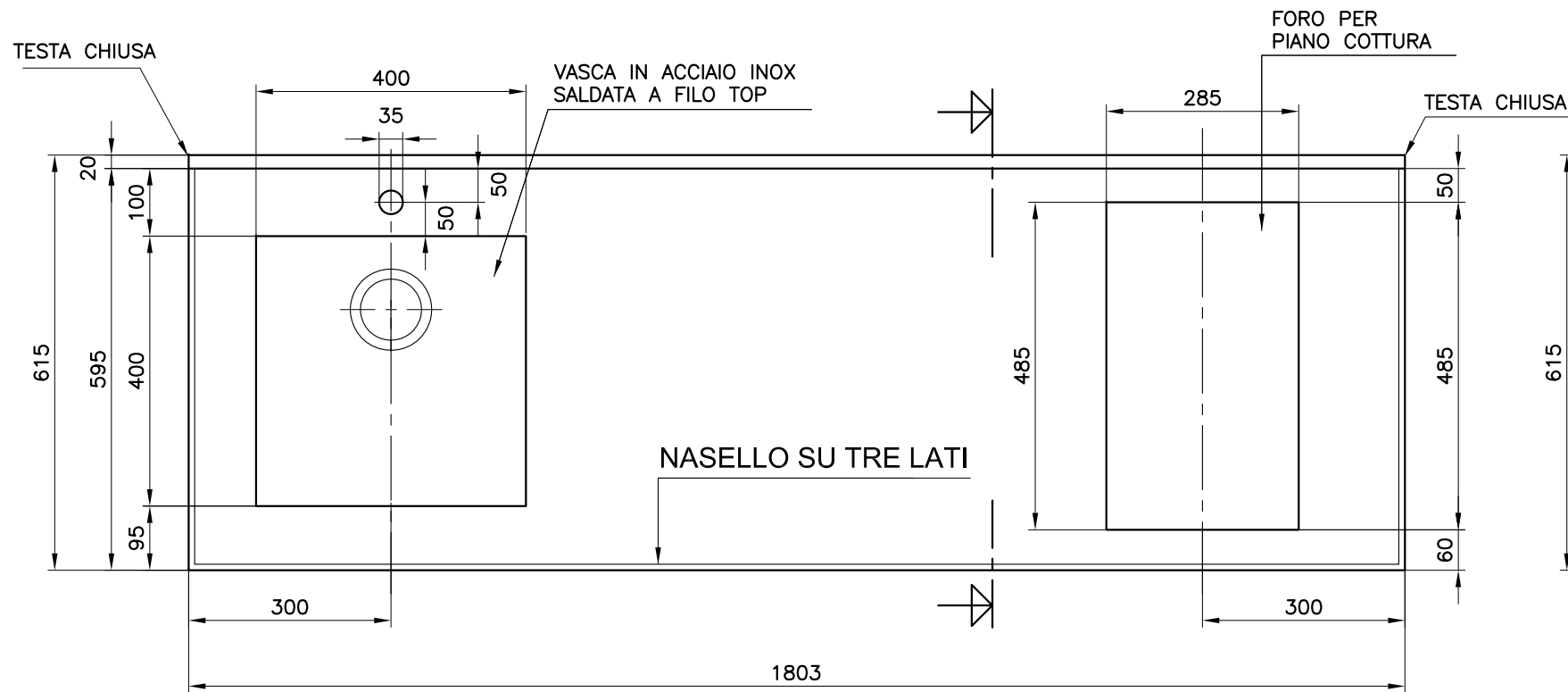

FIANCO

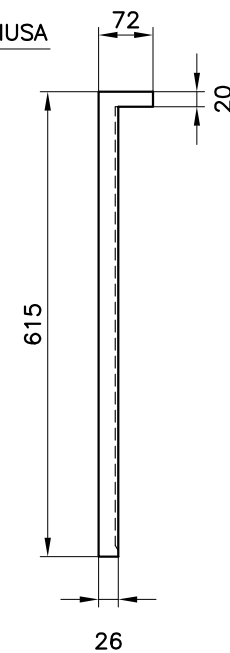

SEZIONE scale 1:1

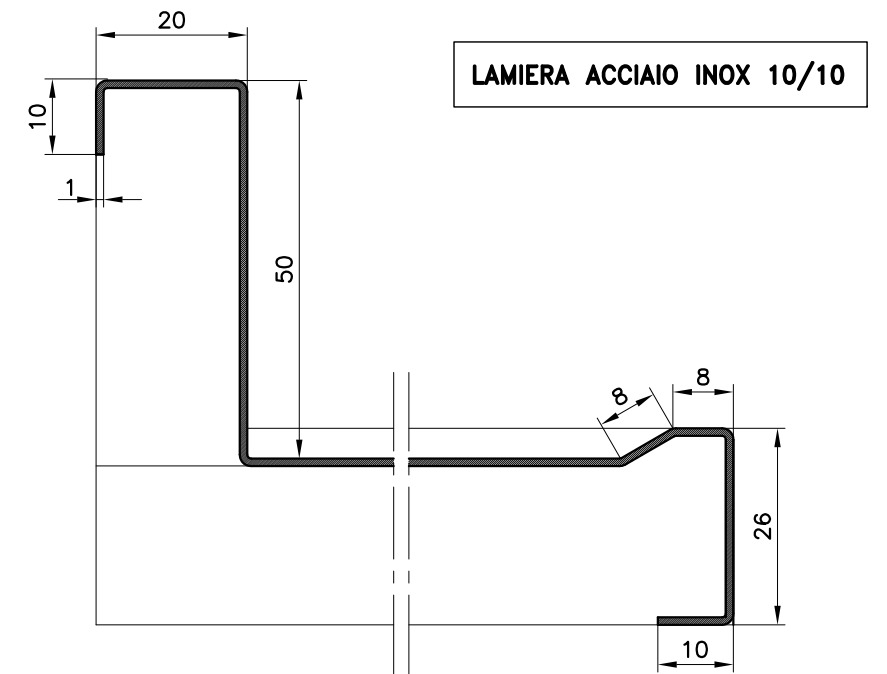

PIANTA DEL TOP - LAVELLO DX / PIANO COTTURA SX

QUANTITA': 3
CAMERE: 4 5 9

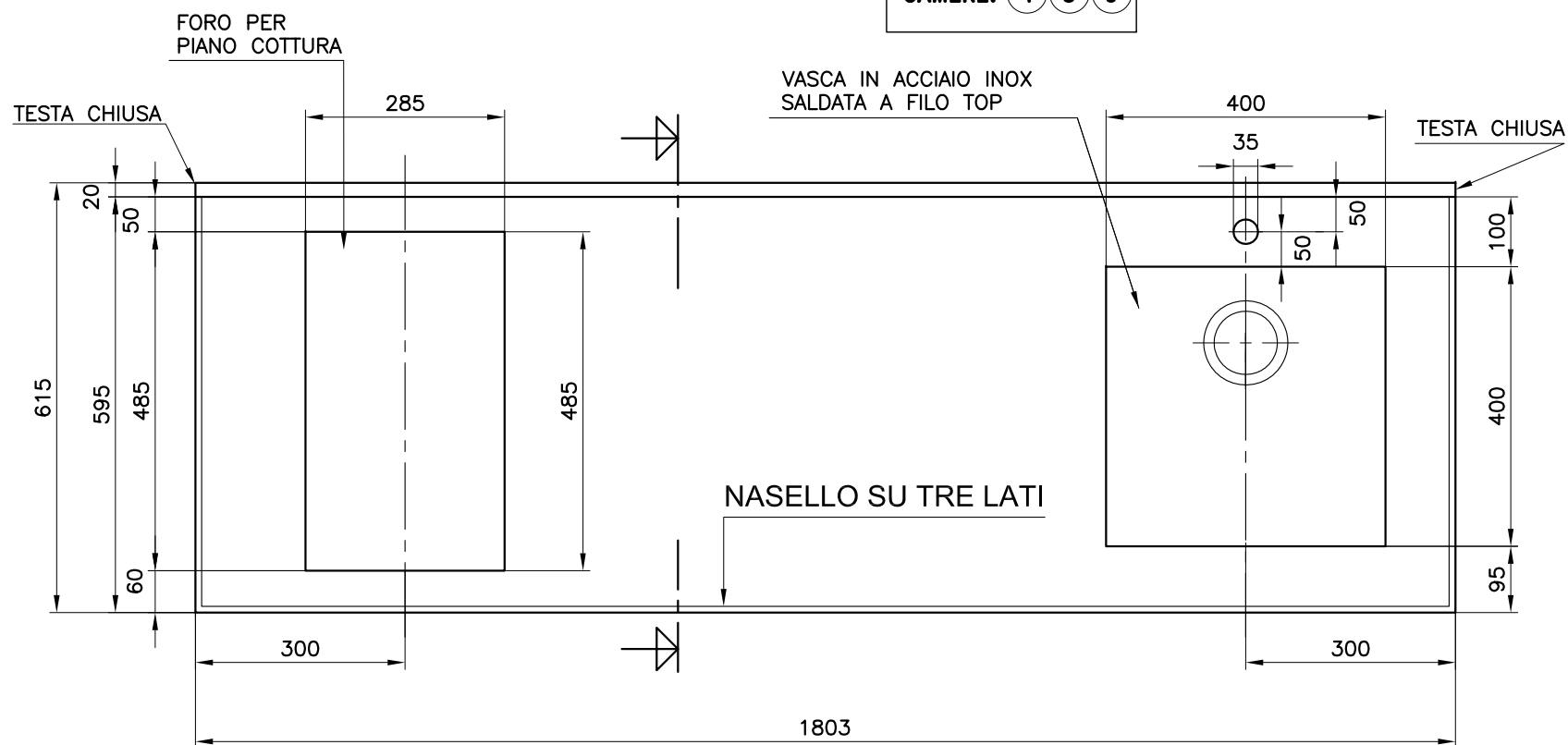

FIANCO

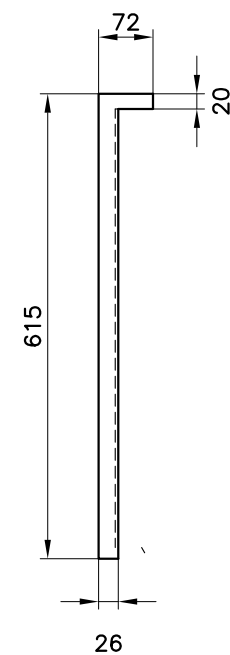

SEZIONE IN ASSIEME scale 1:1

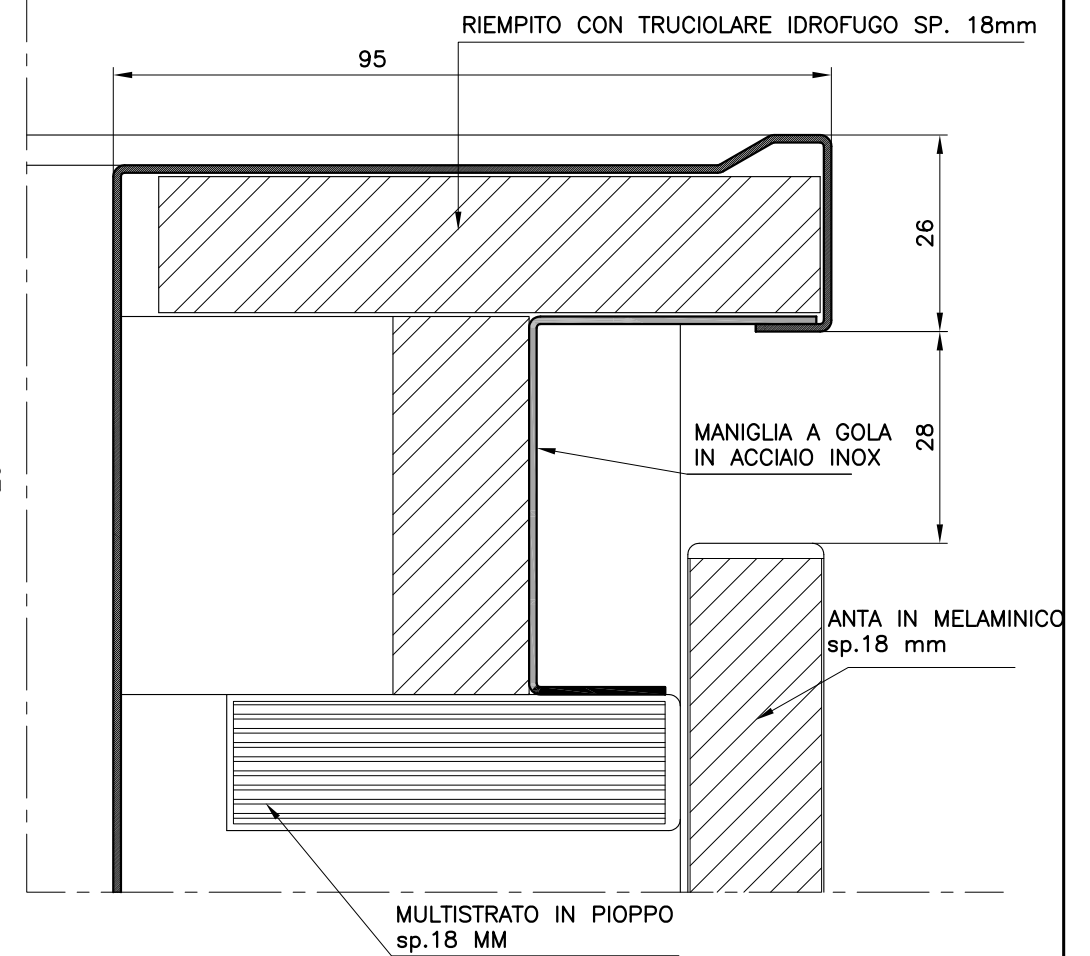

Studio GALMAR		descrizione:	
PROGETTAZIONE e DESIGN - SETTORE ARREDO		TOP CUCINA IN ACCIAIO INOX	
20833 GIUSSANO (MB) Italy - P.zza Repubblica, 1		CAMERE 1-2-4-5-6-7-9	
Tel. +39 0362 351107 - E-mail: info@studlogalmar.it			
PROPRIETA' E DIRITTI RISERVATI, TUTELATI A NORMA DI LEGGE			
progetto:	data:	scala:	formato:
RIVANAZZANO	29-05-2012	1:10	A3
riferimento:	aggiornamenti:	codice documento:	
		RIV D 012	

PIANTA DEL TOP-CUCINA A PENISOLA

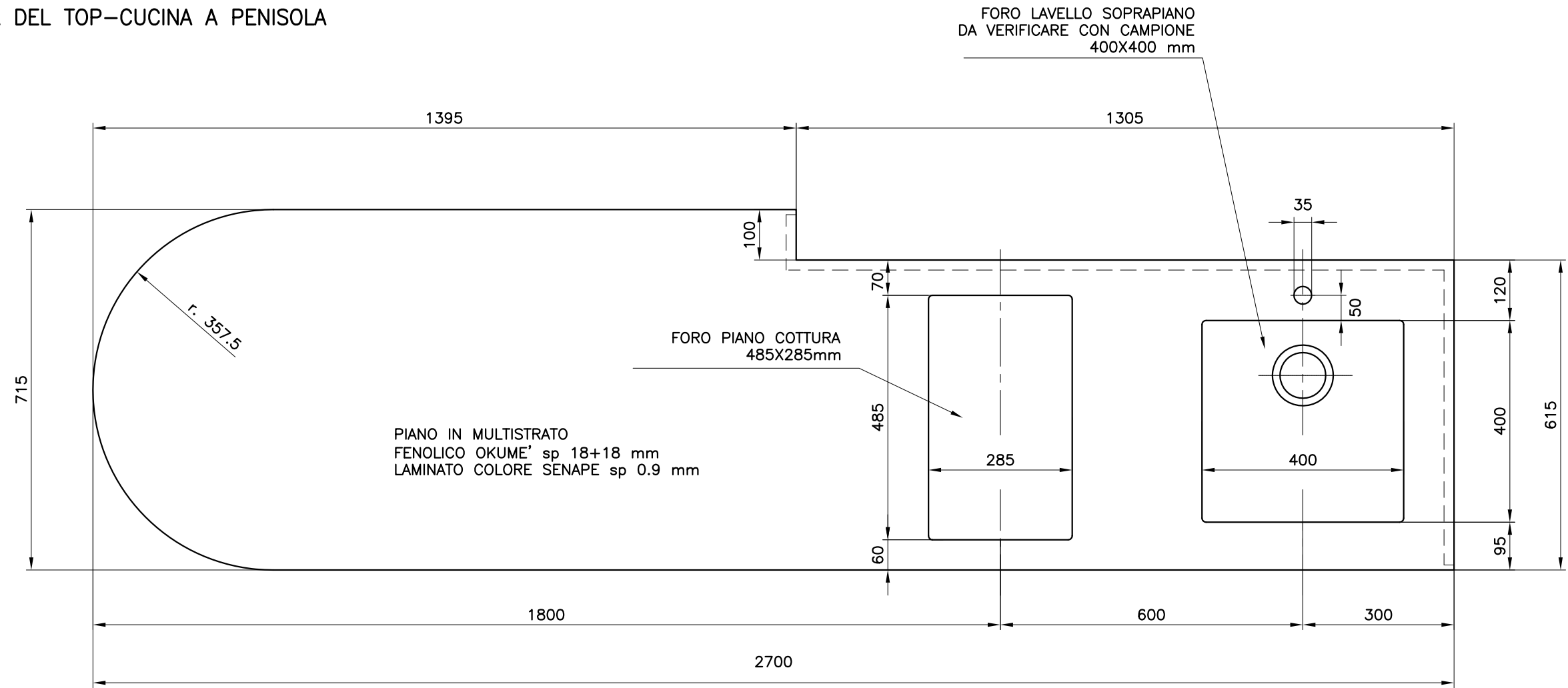

SEZIONE scala 1:1

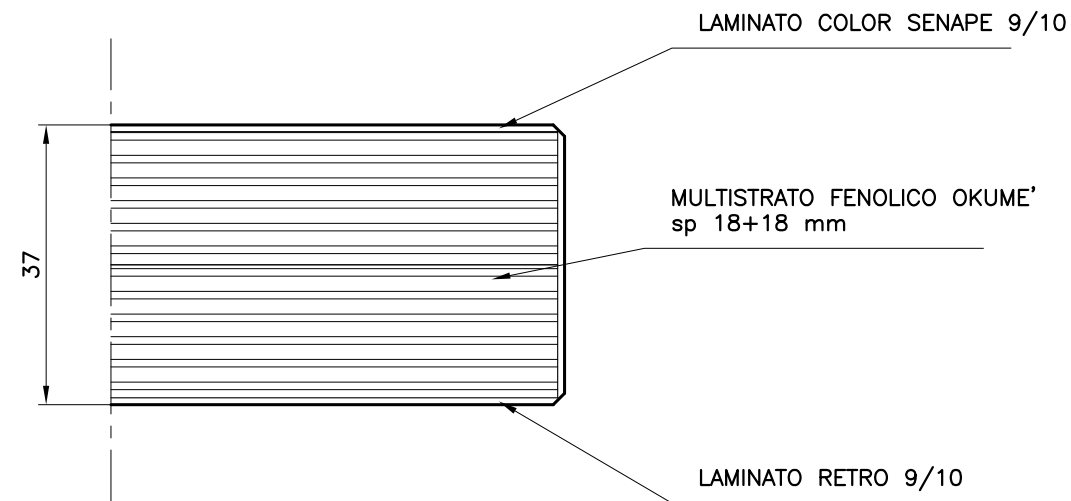

QUANTITA': 1
CAMERE: 3

Studio GALMAR PROGETTAZIONE e DESIGN - SETTORE ARREDO 20833 GIUSSANO (MB) Italy - P.zza Repubblica, 1 Tel. +39 0362 351107 - E-mail: info@studiogalmar.it <small>PROPRIETA' E DIRITTI RISERVATI, TUTELATI A NORMA DI LEGGE</small>		descrizione:	
		TOP CUCINA IN LAMINATO CAMERA 3	
progetto:	data:	scala:	formato:
RIVANAZZANO	31-05-2012	1:10	A3
riferimento:	aggiornamenti:	codice documento:	
		RIV D 003	