

PIANTA

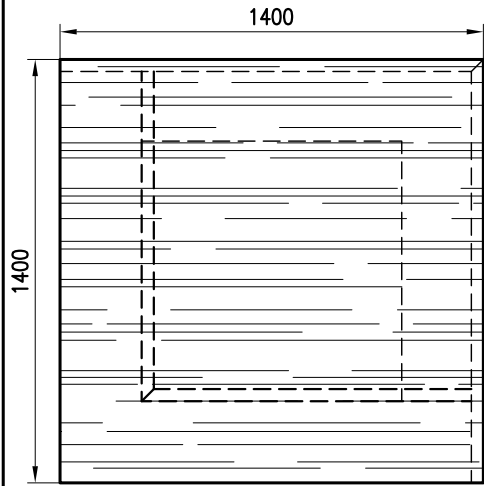

VISTA A

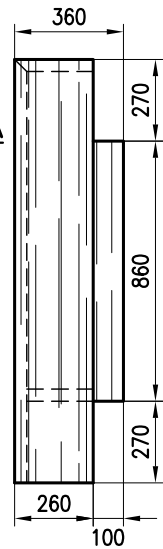

PIANTA

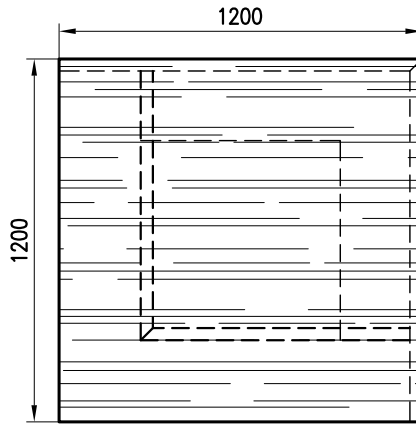

VISTA A

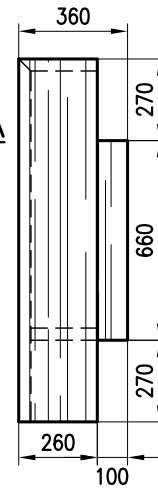

PIANTA

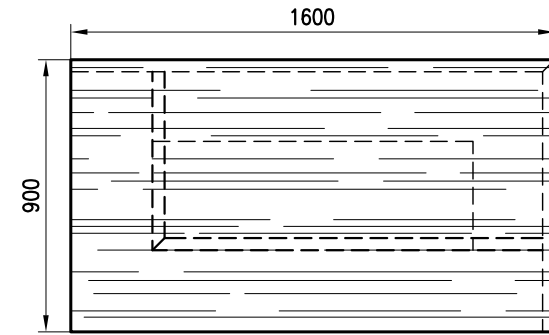

VISTA A

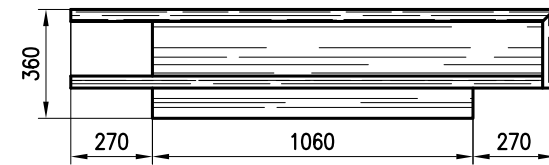
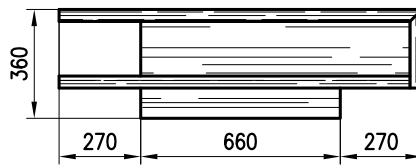
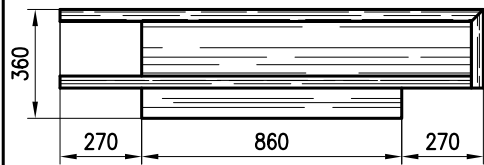
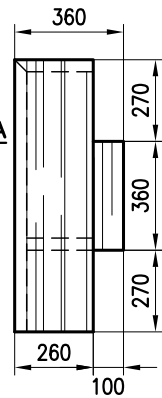

PIANTA

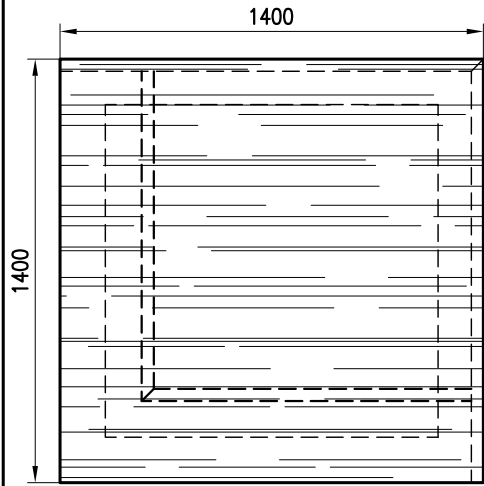

VISTA A

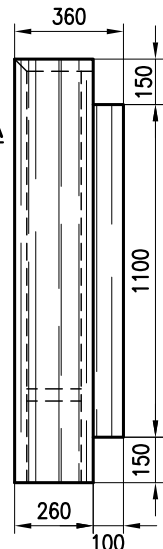

PIANTA

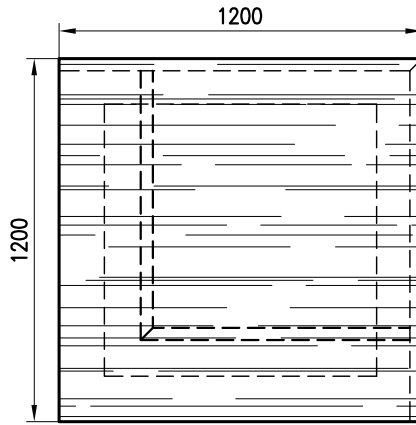

VISTA A

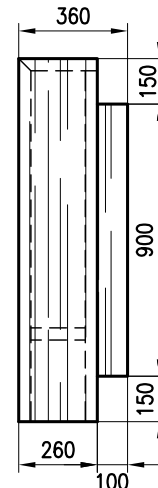

PIANTA

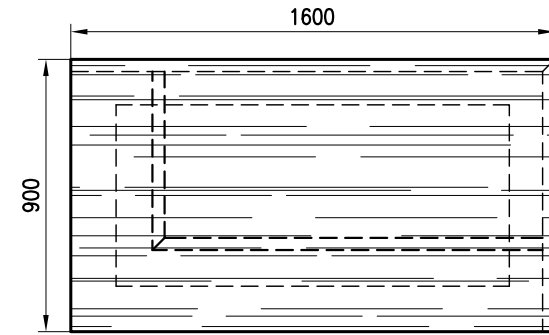

VISTA A

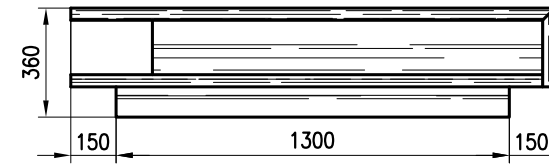
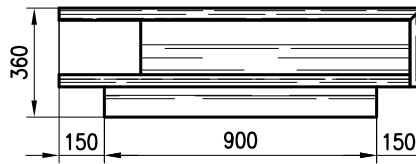
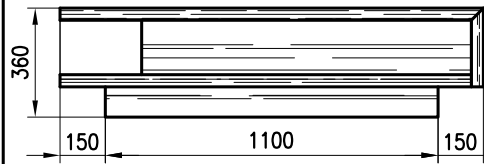
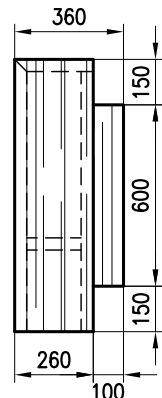

Studio GALMAR

PROGETTAZIONE e DESIGN - SETTORE ARREDO
20153 GIUSSANO (MB) - P.zza Repubblica, 1 - E-mail: info@studiogalmar.it
PROPRIETA' E DIRITTI RISERVATI, TUTELATI A NORMA DI LEGGE

TAVOLINI
BOGART
scala 1:25

PIANTA

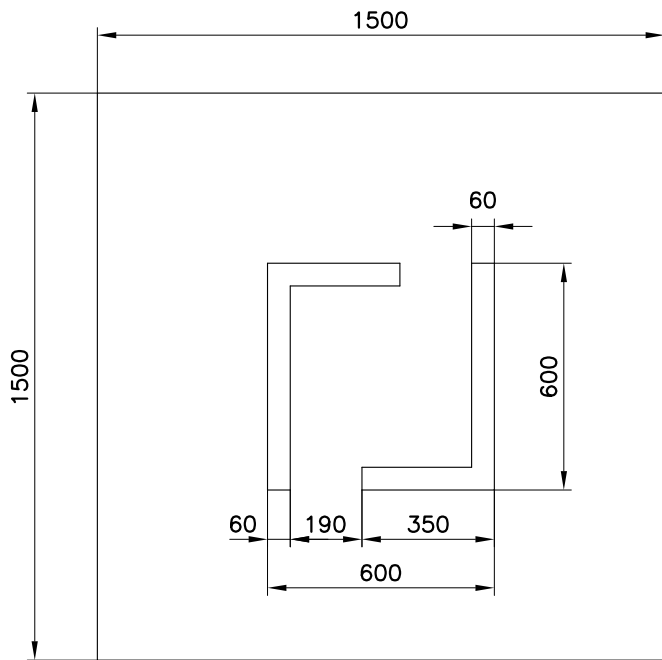

VISTE ASSONOMETRICHE

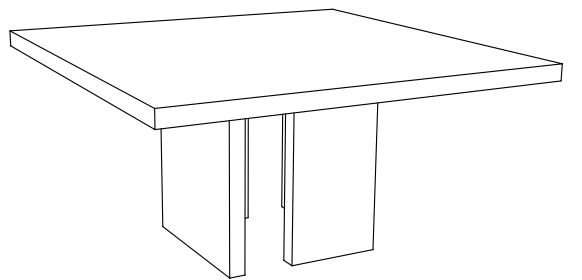
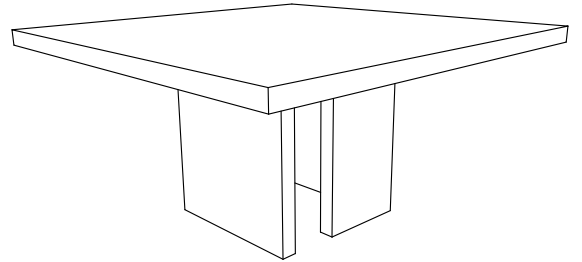

PROSPETTO

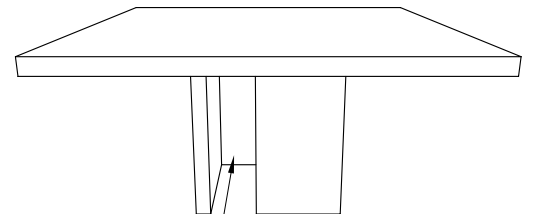
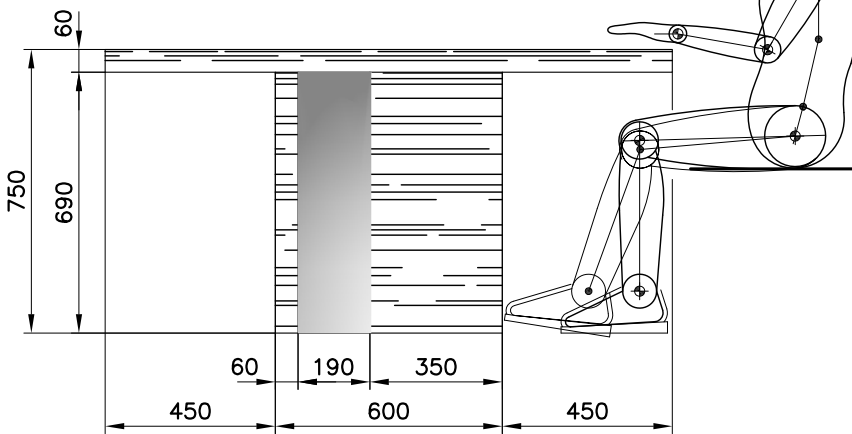

PANNELLO OPZIONALE
LACCATO – COLORI CASAMILANO

Studio GALMAR PROGETTAZIONE e DESIGN - SETTORE ARREDO 20833 GIUSSANO (MB) Italy - P.za Repubblica, 1 Tel. +39 0362 351107 - E-mail: Info@studlogalmar.it <small>PROPRIETA' E DIRITTI RISERVATI, TUTELATI A NORMA DI LEGGE</small>		descrizione:	
		VISTE GENERALI PROPOSTA 1	
articolo:	data:	scala:	formato:
TAVOLO 2011	09-11-2010	1:20	A4
	aggiornamenti:	codice documento:	
		TAV D 001	

PIANTA

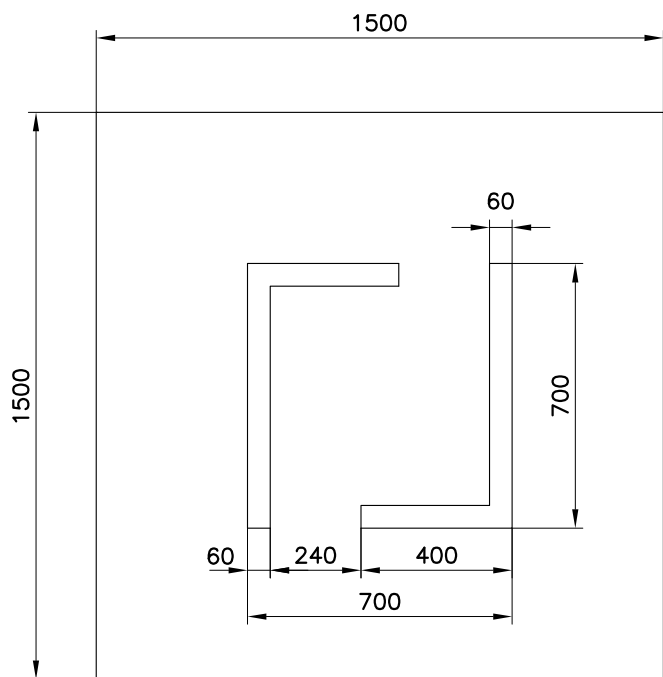

VISTE ASSONOMETRICHE

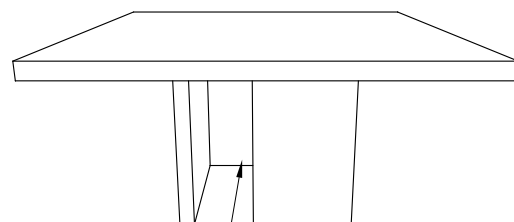
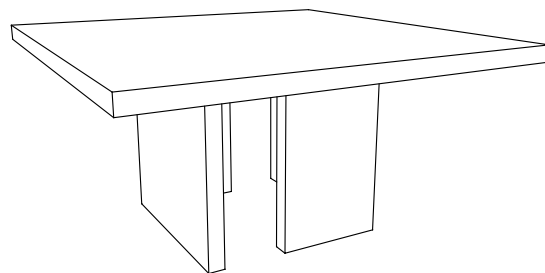
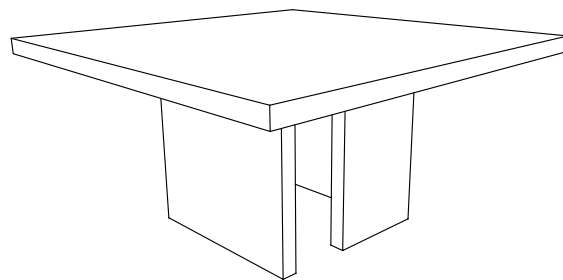

PANNELLO OPZIONALE
LACCATO - COLORI CASAMILANO

PROSPETTO

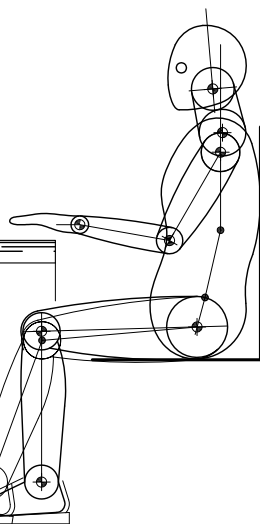
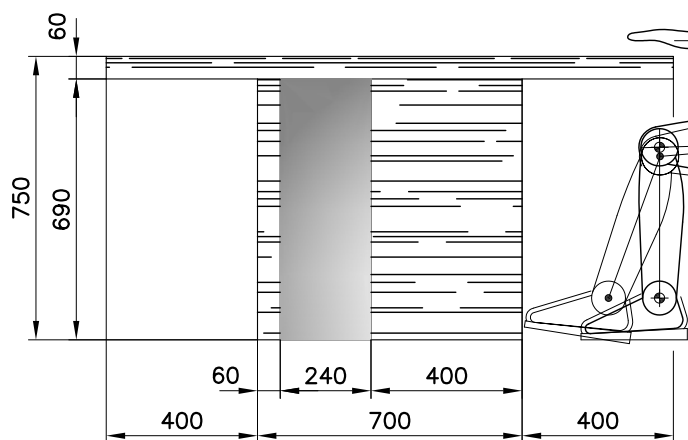

Studio GALMAR PROGETTAZIONE e DESIGN - SETTORE ARREDO 20833 GIUSSANO (MB) Italy - P.zza Repubblica, 1 Tel. +39 0362 351107 - E-mail: Info@studogalmar.it <small>PROPRIETA' E DIRITTI RISERVATI, TUTELATI A NORMA DI LEGGE</small>		descrizione:	
		VISTE GENERALI PROPOSTA 2	
articolo:	data:	scala:	formato:
TAVOLO 2011	09-11-2010	1:20	A4
	aggiornamenti:	codice documento:	
		TAV D 001	

PIANTA

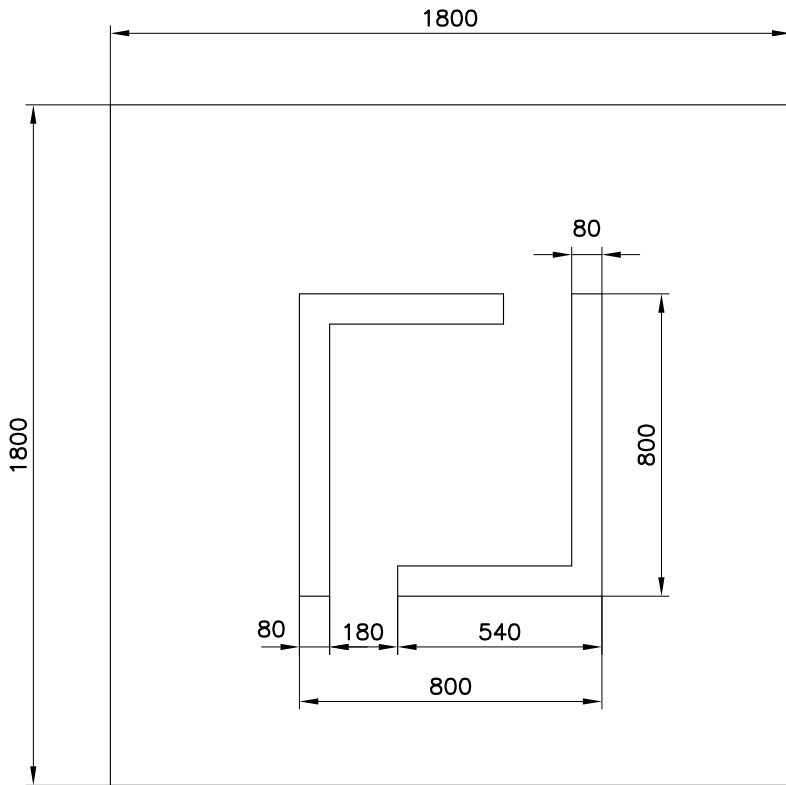

VISTE ASSONOMETRICHE

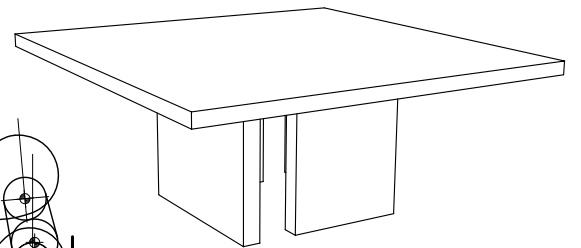
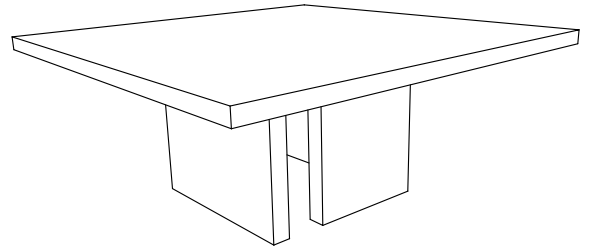

PROSPETTO

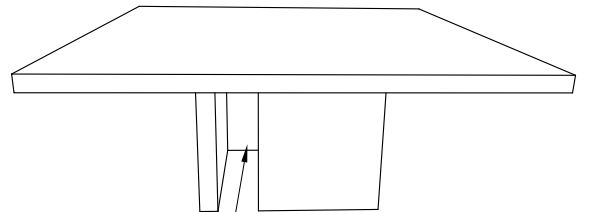
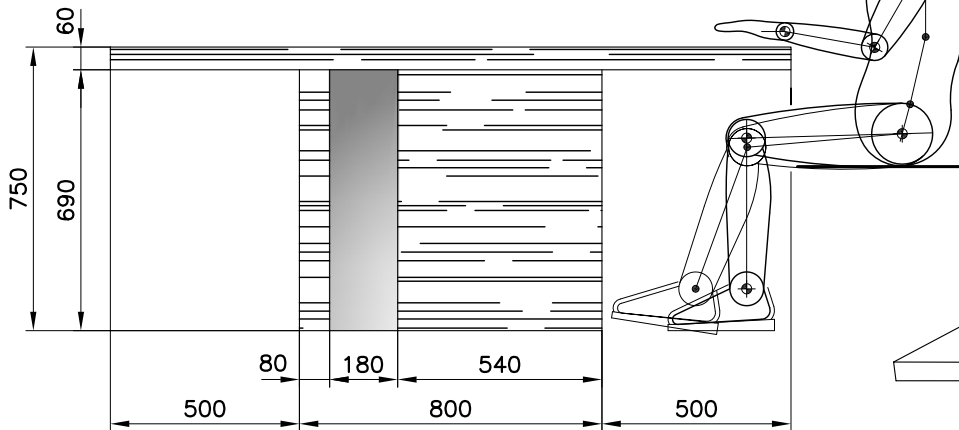

PANNELLO OPZIONALE
LACCATO - COLORI CASAMILANO

Studio GALMAR PROGETTAZIONE e DESIGN - SETTORE ARREDO 20833 GIUSSANO (MB) Italy - P.za Repubblica, 1 Tel. +39 0362 351107 - E-mail: Info@studlogalmar.it <small>PROPRIETA' E DIRITTI RISERVATI, TUTELATI A NORMA DI LEGGE</small>		descrizione:	
		VISTE GENERALI PROPOSTA 3	
articolo:	data:	scala:	formato:
TAVOLO 2011	09-11-2010	1:20	A4
	aggiornamenti:	codice documento:	
		TAV D 001	

PIANTA

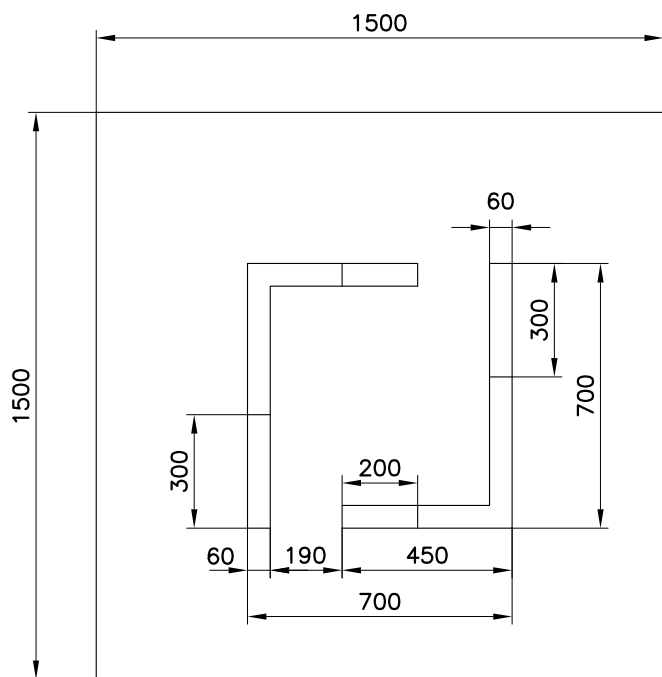

VISTE ASSONOMETRICHE

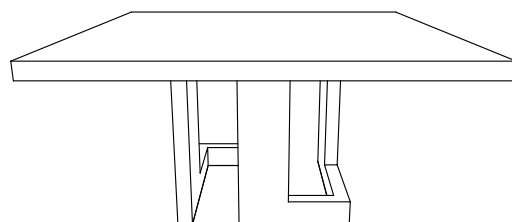
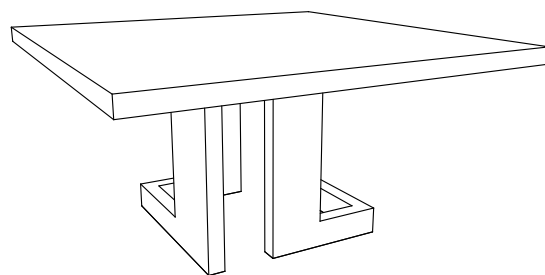
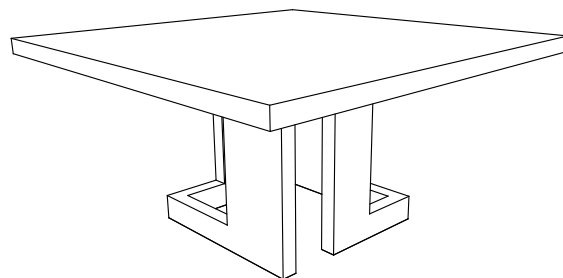

PROSPETTO

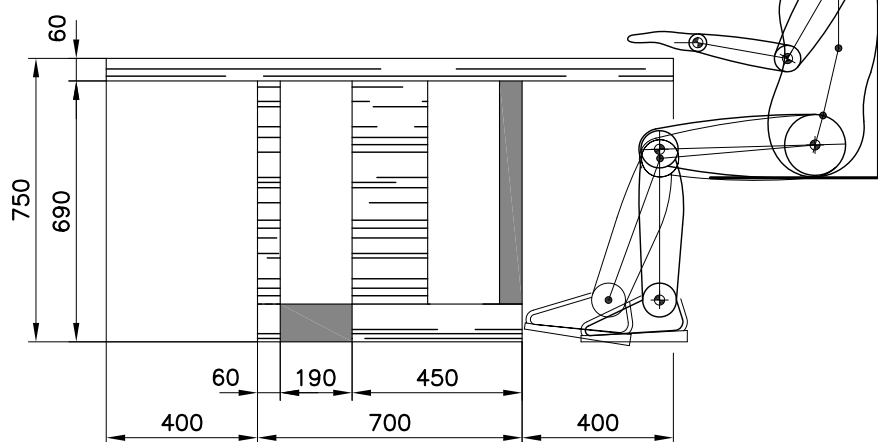

Studio GALMAR PROGETTAZIONE e DESIGN - SETTORE ARREDO 20833 GIUSSANO (MB) Italy - P.za Repubblica, 1 Tel. +39 0362 351107 - E-mail: info@studogalmar.it <small>PROPRIETA' E DIRITTI RISERVATI, TUTELATI A NORMA DI LEGGE</small>		descrizione:	
		VISTE GENERALI PROPOSTA 4	
articolo:	data:	scala:	formato:
TAVOLO 2011	11-11-2010	1:20	A4
	aggiornamenti:	codice documento:	
		TAV D 001	

PIANTA

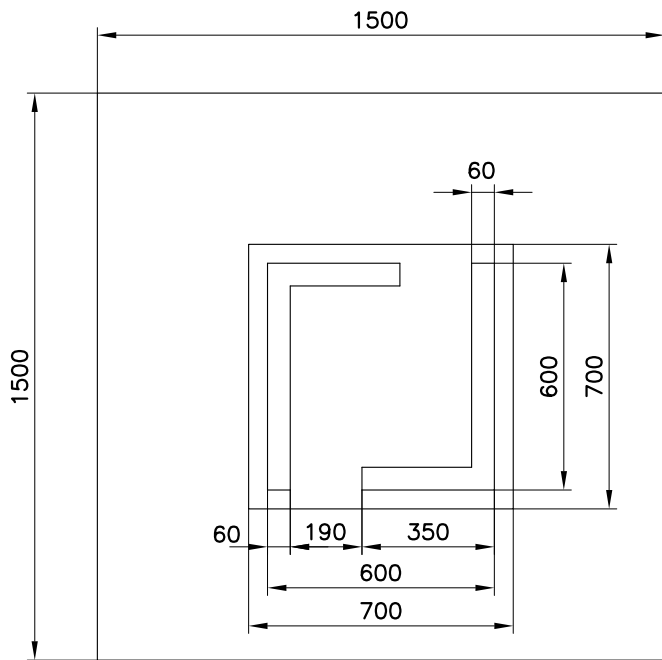

VISTE ASSONOMETRICHE

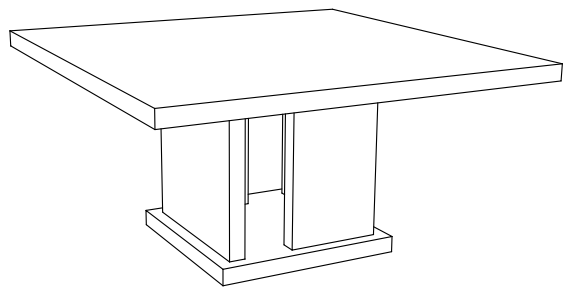
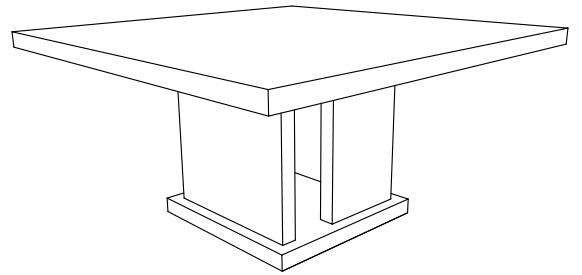

PROSPETTO

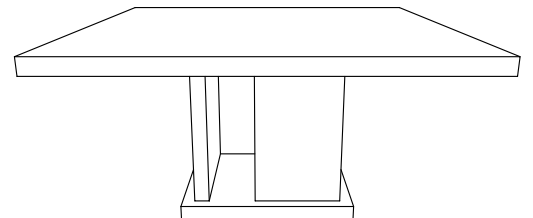
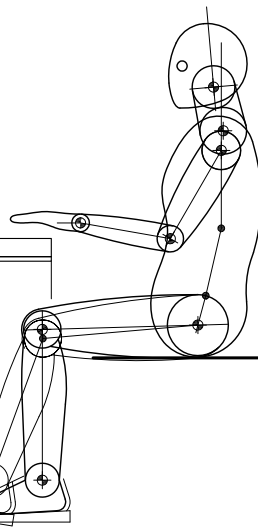
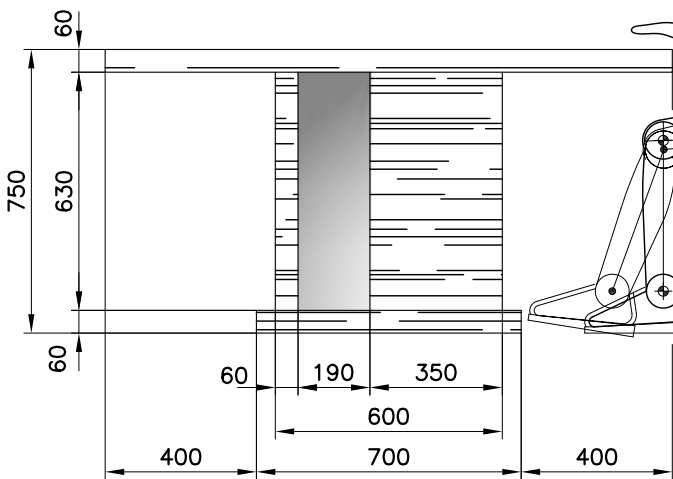

Studio GALMAR PROGETTAZIONE e DESIGN - SETTORE ARREDO 20833 GIUSSANO (MB) Italy - P.za Repubblica, 1 Tel. +39 0362 351107 - E-mail: info@studogalmar.it <small>PROPRIETA' E DIRITTI RISERVATI, TUTELATI A NORMA DI LEGGE</small>		descrizione:	
		VISTE GENERALI PROPOSTA 5	
articolo:	data:	scala:	formato:
TAVOLO 2011	11-11-2010	1:20	A4
	aggiornamenti:	codice documento:	
		TAV D 001	